

## User Guide

English .....	3
Deutsch.....	9
Français.....	16
Español .....	23
Italiano .....	30
Dutch .....	37
Korean.....	44
Norwegian .....	51
Danish.....	58
Japanese.....	65
Simplified Chinese....	72
Finnish .....	79
Swedish.....	86
Russian .....	93

iPhone and iPod not included / iPhone et iPod non inclus



JBL On Stage™ IIIIP portable loudspeaker dock for iPhone and iPod



# JBL On Stage™\* IIIP Important Safety Instructions

Please read the following precautions before use:

- Read these instructions, heed all warnings, and keep for future reference.
- Do not use this apparatus near water.
- Clean only with dry cloth.
- Do not block any ventilation openings; a minimum distance of 10mm around the entire apparatus is required for sufficient ventilation.
- No naked flame sources such as lighted candles should be placed on or near apparatus.
- Attention should be drawn to the environmental aspects of battery disposal.
- Apparatus is to be used in moderate climates only.
- Do not install near any heat sources such as radiators, heat registers, stoves or other apparatuses (including amplifiers) that produce heat.
- Do not defeat the safety purpose of the polarized or grounding-type plug. A polarizing plug has two blades with one wider than the other. A grounding-type plug has two blades and a third grounding prong. The wide blade or third prong is provided for safety. If the provided plug does not fit into your outlet, consult an electrician for replacement of the obsolete outlet.
- Protect the power cord from being walked on or pinched, particularly at the plugs and convenience receptacles, and at the point where they exit from the apparatus.
- Only use attachments/accessories specified by the manufacturer.
- Unplug this apparatus during lightning storms or when unused for long periods of time.
- Refer all servicing to qualified service personnel. Servicing is required when the apparatus has been damaged in any way, such as power-supply cord or plug is damaged, liquid has been spilled or objects have fallen into the apparatus, or the apparatus has been exposed to rain or moisture, does not operate normally, or has been dropped.
- To be completely disconnected from the power input, the main plug of AC/DC adaptor shall be disconnected from the main.
- The main plug of AC/DC adaptor should not be obstructed OR should be easily accessed during intended use.
- The marking information is located at the bottom of apparatus.
- Battery shall not be exposed to excessive heat such as sunshine, fire or the like.
- The apparatus and AC/DC adaptor shall not be exposed to dripping or splashing and that no objects filled with liquids, such as vases, shall be placed on apparatus and AC/DC adaptor.
- TO PREVENT THE RISK OF ELECTRIC SHOCK, DO NOT REMOVE THE COVER (OR BACK). THERE ARE NO USER-SERVICEABLE PARTS INSIDE THIS UNIT. PLEASE REFER SERVICING TO QUALIFIED HARMAN CONSUMER GROUP, INC., SERVICE PERSONNEL.
- Never remove grille covers in order to service the speaker system. The speaker system does not contain any user-serviceable parts.

## IMPORTANT:

The appropriate adapter must be installed before inserting your iPod into the JBL On Stage IIIP. Make sure that the iPod connector is properly aligned with the JBL On Stage IIIP's connector when installing your iPod. Failure to do so may cause permanent damage to the iPod connector, rendering the iPod inoperable.

## Important Note for All Electronic Products:

Before inserting or unplugging audio cables from the source device's headphones or line-level output jacks, it is good practice to turn off the device first. This will prolong the life of your unit, help protect your device from static electricity and prevent potential damage.

**WARNING:** TO PREVENT FIRE OR ELECTRICAL SHOCK HAZARD, DO NOT EXPOSE THIS PRODUCT TO RAIN OR MOISTURE.

**WARNING:** THE APPARATUS SHOULD NOT BE EXPOSED TO DRIPPING OR SPLASHING AND NO OBJECTS FILLED WITH LIQUID, SUCH AS VASES, SHOULD BE PLACED ON THE APPARATUS.

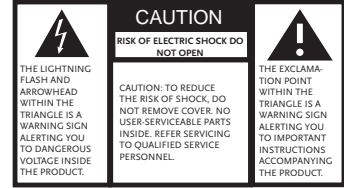

## fcc regulations

### FCC Declaration of Conformity Statement

This device complies with Part 15 of the FCC Rules. Operation is subject to the following two conditions: (1) This device may not cause harmful interference; and (2) this device must accept any interference received, including interference that may cause undesired operation.

### Radio and Television Interference

This equipment has been tested and found to comply with the limits for a Class B digital device, pursuant to Part 15 of the FCC Rules. These limits are designed to provide reasonable protection against harmful interference in a residential installation. This equipment generates, uses and can radiate radio frequency energy and, if not installed and used in accordance with the instructions, may cause harmful interference to radio communications. However, there is no guarantee that interference will not occur in a particular installation.

If this equipment does cause interference to radio or television reception, which can be determined by turning the equipment off and then on, the user is encouraged to try to correct the interference by one or more of the following measures:

- Increase the separation between the equipment and receiver.
  - Connect the equipment to a different outlet so that the equipment and receiver are on different branch circuits.
  - Consult the dealer or an experienced radio/TV technician for help.
- Changes or modifications not expressly approved by JBL, Inc., could void the user's authority to operate the equipment.

## Unpacking

Carefully unpack your JBL On Stage™ IIIP and identify all its components:

### 1. JBL On Stage IIIP

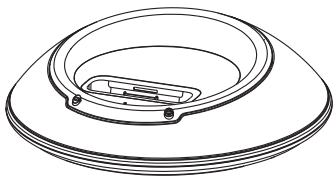

### 4. Dock adapter for iPod



### 2. Power adapter



### 5. 3.5mm Audio cable



### 3. IR remote

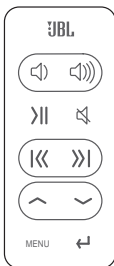

## Getting to know your JBL On Stage IIIP

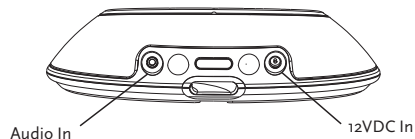

## Adapters for iPod



For detailed information regarding selection, installation and removal of the dock adapters, visit [www.jbl.com](http://www.jbl.com).

To remove an adapter, insert a flat-head screwdriver (sold separately) into the slot on the back of the adapter and lift up.

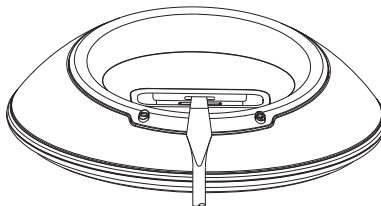
Make sure your iPod is securely docked into the JBL On Stage IIIP, using the correct adapter.

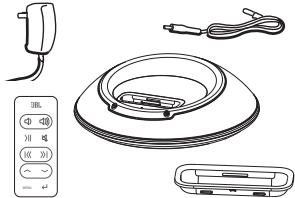
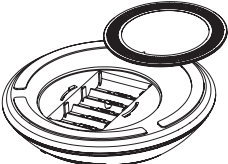
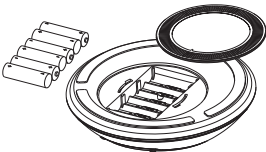
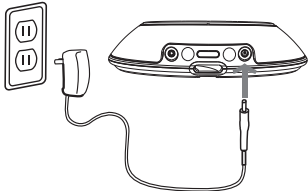

# JBL On Stage IIIIP easy setup guide

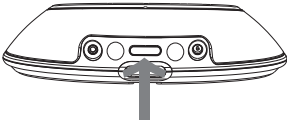
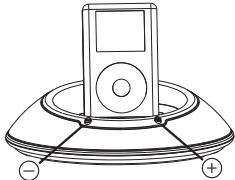
			
<p>Step 1. Unpack the JBL On Stage IIIIP, adapter, remote control, power adapter and input cable. Read these instructions completely.</p>	<p>Step 2. Rotate the battery door to the unlocked position to open the battery compartment.</p>	<p>Step 3. Place 6 AA batteries in the battery compartment.</p>	<p>Step 4. Connect the power adapter into the input marked on the rear of the JBL On Stage IIIIP; plug the power adapter into a wall outlet or power strip.</p>
	<p>or</p> 		
<p>Step 5. Place the appropriate iPod adapter onto JBL On Stage IIIIP. Place your iPod on the docking connector or connect the audio input cable to the rear of the JBL On Stage IIIIP. Connect the audio cable to the audio source.</p>		<p>Step 6. Press the Power button on the back of the JBL On Stage IIIIP. A green LED will light when the JBL On Stage IIIIP system is on.</p>	<p>Step 7. Adjust the volume using (+) to increase and (-) to decrease. Press both to mute the JBL On Stage IIIIP. Press either button to unmute.</p>

## Battery Disposal

Alkaline batteries are considered nonhazardous and can be disposed of with your regular household trash.

Rechargeable batteries (i.e., nickel cadmium, nickel metal-hydrate, lithium and lithium-ion) are considered hazardous household materials and may pose an unnecessary health and safety risk. Unwanted materials should be disposed of in an environmentally sound manner. Contact your local waste management officials for other information regarding the environmentally sound collection, recycling and disposal of used batteries.

DO NOT MIX BATTERY TYPES  
DO NOT MIX CHARGED AND PARTIALLY CHARGED BATTERIES  
BATTERIES WILL NOT RECHARGE WHILE IN JBL ON STAGE IIIIP

# JBL On Stage III remote easy setup guide

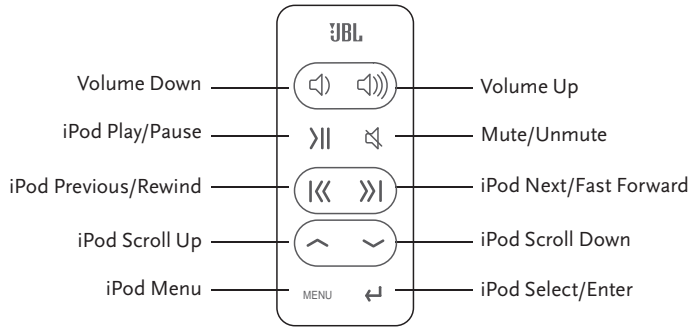

Transmission:	IR
Frequency:	38kHz
Operating Range:	20 feet
Battery Type:	CR2025 3V
Dimensions:	
Width:	1.29" (33mm)
Height:	3.38" (86mm)
Depth:	0.23" (6mm)
Weight (including battery):	1.2 oz.

## Navigation Control Mode

- Turn iPod on: Press any button on the remote control to wake the iPod.
- Turn iPod off: Press and hold the Play/Pause button for two seconds.
- Bring up iPod menu: Press the Menu button.
- Scroll up: Press the Scroll Up button.
- Scroll down: Press the Scroll Down button.
- Go to previous menu: Press the Menu button.
- Select menu/track/feature: Press the Select button.

## Music Control Mode

- Play a track: Press the Play/Pause button.  
**Note:** If the iPod is at the Main Menu, pressing Play/Pause will cause the iPod to start playing all of its music.
- Pause a track: Press the Play/Pause button while a song is playing.
- Skip to next track: Press the Next/Fast Forward button.
- Skip to previous track: Press the Previous/Rewind button.
- Fast-advance track: Press and hold the Next/Fast Forward button.
- Fast-reverse track: Press and hold the Previous/Rewind button.
- Increase volume: Press the Volume Up button.
- Decrease volume: Press the Volume Down button.
- Mute: Press the Mute/Unmute button.
- Go to previous menu: Press the Menu button.
- Select menu/track/feature: Press the Select/Enter button.

# troubleshooting your JBL On Stage IIIIP

Technical Specifications	Symptom	Possible Problem	Solution	
	Sound Quality			
<p>Frequency Response: 70Hz – 20kHz</p> <p>Power Consumption: 20W Maximum</p> <p>Power Input: 12V/1.5A</p> <p>JBL On Stage IIIIP Transducer: (4) 1" Full range per channel</p> <p>Dimensions: Diameter – 7 1/2" (190mm) Height – 2" (51mm)</p> <p>System Weight: 1.12 lb (0.51kg)</p> <p>Battery: Size – AA Type – Alkaline, NiMh</p> <p>DO NOT MIX BATTERY TYPES. DO NOT MIX CHARGED AND PARTIALLY CHARGED BATTERIES. BATTERIES WILL NOT RECHARGE WHILE IN JBL ON STAGE IIIIP.</p>	<p>No sound from the JBL On Stage IIIIP speaker system</p>	<p>No power to the system</p> <p>Power adapter plug is not inserted correctly</p>	<p>Ensure that the power supply is connected to a live power source and properly connected to the JBL On Stage IIIIP. Note: When the JBL On Stage IIIIP is powered, a green power LED on the JBL On Stage IIIIP should light up.</p>	
		<p>No volume or low volume</p>	<p>Touch the volume "Up" (+) pad on the volume control to unmute and/or increase the system volume level.</p> <p>Note: Touching the volume "Down" (-) pad lowers the system volume. Touching both the (+) and (-) volume control pads at the same time will mute the system.</p>	
		<p>Input source volume is low</p>	<p>Increase the volume level on the audio source device.</p>	
		<p>Low or drained batteries</p>	<p>Replace the batteries.</p>	
		<p>iPod is paused</p>	<p>Press the Play button on the iPod or remote control.</p>	

If you have any questions or need further assistance, please visit [www.jbl.com](http://www.jbl.com). Features, specifications and appearance are subject to change without notice.

Symptom	Possible Problem	Solution
<b>Sound Quality</b>		
No power; green LED is not on	Wall adapter is not plugged into the JBL On Stage IIIP correctly.	Check the connection of the wall adapter.
	Wall adapter is not receiving AC power	Place the wall adapter in a known powered outlet. Test the outlet with a lamp or other device.
<b>Charging</b>		
iPod will not charge	No power to input	Check input cable connection.
	Wrong adapter is used	Replace adapter.
	iPod is not making full contact with the docking station	Turn the JBL On Stage IIIP off and connect it to another wall outlet.

JBL is a trademark of Harman International Industries, Incorporated, registered in the United States and/or other countries.

\* The trademark On Stage is used with permission of OSA International, Inc.

iPod is a trademark of Apple Inc., registered in the U.S. and other countries. iPhone is a trademark of Apple Inc. iPod and iPhone not included. "Made for iPod" means that an electronic accessory has been designed to connect specifically to iPod and has been certified by the developer to meet Apple performance standards. "Works with iPhone" means that an electronic accessory has been designed to connect specifically to iPhone and has been certified by the developer to meet Apple performance standards. Apple is not responsible for the operation of this device or its compliance with safety and regulatory standards.

JBL est une marque commerciale de Harman International Industries, Incorporated, déposée aux États-Unis et/ou dans d'autres pays.

\* Le marque "On Stage" est utilisée avec la permission de OSA International, Inc.

iPod est une marque commerciale de Apple Inc., déposée aux États-Unis et dans d'autres pays. iPhone est une marque commerciale de Apple Inc. iPod et iPhone non inclus. « Made for iPod » signifie qu'un accessoire électronique a été conçu pour ce connecter spécifiquement à l'iPod et que sa conformité aux normes de performances Apple a été certifiée par son constructeur. « Works with iPhone » signifie que le dispositif électronique a été spécialement conçu pour se connecter à l'iPhone et qu'il est certifié par le développeur comme conforme aux normes de performance Apple. Apple n'est pas responsable du fonctionnement de ce dispositif ou de sa conformité avec les normes de sécurité ou réglementaires.

**Harman Consumer Group, Inc.**

8500 Balboa Boulevard, Northridge, CA 91329 USA

1.516.255.4525 (USA only)

[www.jbl.com](http://www.jbl.com)

© 2008 Harman International Industries, Incorporated. All rights reserved. Tous droits réservés.

Document Number: 950-0234-001 Rev. C

**H** A Harman International Company



®